

LETO 11

WALL MOUNT UP/DOWN WET LED CYLINDER



Features

- Faceted and Smooth metal reflectors provide beam spreads between 10° to 80°.
- Nine drivers selections available to cover wide range of applications.
- Two output options available up to 1000 lumens.
- 5 year warranty.

Finish Options

- White
- Black
- Silver
- Mocha
- Charcoal
- Cerulean
- Firebrick



Declare. Made in Canada with Imported Parts

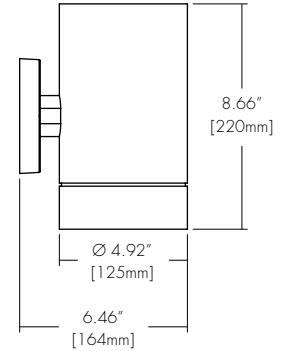

Technical Information

OUTPUT OPTIONS		700 lm	1000 lm
DOWN	Fixture wattage	6.1 W	9.1 W
	Delivered Lumen at 3500K	656 lm	994 lm
	Efficacy	108 lm/W	109 lm/W
	Center Beam Candlepower (10° Faceted Reflector)	5474 cd	8294 cd
UP	Fixture wattage	6.1 W	9.1 W
	Delivered Lumen at 3500K	614 lm	857 lm
	Efficacy	101 lm/W	94 lm/W

CCT	Multiplier	CRI	TM-30		
			R _f	R _g	R ₉
2500K	0.81	92	90	104	77
2700K	0.92	92	91	102	61
3000K	0.97	95	92	102	61
3500K	1.00	95	93	101	72
4000K	1.07	95	92	103	68
6500K	1.05	96	91	100	89

Integral Driver Example: Fixture LET11W-WM-0707-25K-F10-F17-CL-WH-WH-PHSD-NA

Remote Driver Example: Fixture LET11W-WM-0707-25K-F10-F17-CL-WH-WH-010L-NA
HRM-LET11W-WM-0707-25K-010L-NA

Ordering Code

Fixture

MODEL	TYPE	OUTPUT	CCT	OPTIC	OPTIC UP	ACCESSORY	BODY FINISH	BAFFLE FINISH
LET11W - Leto 11 Wet	WM - Wall Mount	0707 - 700 lumens Down, 700 lumens up 1010 - 1000 lumens Down, 1000 lumens up	25K - 2500K 27K - 2700K 30K - 3000K 35K - 3500K 40K - 4000K 65K - 6500K	F10 - 10 Degree, Faceted F18 - 18 Degree, Faceted F30 - 30 Degree, Faceted F45 - 45 Degree, Faceted F60 - 60 Degree, Faceted S30 - 30 Degree, Smooth S45 - 45 Degree, Smooth S80 - 80 Degree, Smooth	F17 - 17 Degree, Faceted F24 - 24 Degree, Faceted F60 - 60 Degree, Faceted	CL - Clear Lens DL - Diffusing Lens	Standard WH - White BK - Black SL - Silver Premium ¹ MA - Mocha CC - Charcoal CR - Cerulean FB - Firebrick	Standard WH - White BK - Black SL - Silver Premium ¹ MA - Mocha CC - Charcoal CR - Cerulean FB - Firebrick

DRIVER²

DRIVER OPTIONS⁴

PHSD - Forward/Reverse Phase, 1% Dimming, 120V Only²
 010S - 0-10V, 1% Dimming, 120/277V²
 0103 - 0-10V, 1% Dimming, 347V Only
 010L - EldoLED, 0-10V, Linear, 0.1% Dimming, 120/277V
 010G - EldoLED, 0-10V, Log, 0.1% Dimming, 120/277V
 DALI - EldoLED, DALI Protocol 2, DT-6, 0.1% Dimming, 120/277V (Standard as LOG)⁵
 DALI8 - EldoLED, DALI Protocol 2, DT-8, 0.1% Dimming, 120/277V (Standard as LOG)⁵
 LUTE - Lutron Hilume Ecodigital, 1% Dimming, 120V/277V
 DMX - EldoLED, DMX, 0.1% Dimming, 120V/277V

NA - None
 EMG - Emergency Driver³

1 - Premium finishes may have extended lead times. Custom RALs are available, please consult Inside Sales with specific request.
 2 - All drivers remote except PHSD/010S driver options
 3 - Emergency option comes prewired from factory with driver in remote housing. 8W of continuous power provided for a minimum of 90 minutes. Must be installed within 30 feet of luminaire using 18 AWG wire. Not available with 0103, DMX, DALI8 or LUTE Driver.
 4 - AWWNR/CSMB available upon request, contact Senso for details.
 5 - DALI and DALI8 driver options use logarithmic dimming curve as standard. For LINEAR dimming curve, add "LIN" after the dimming code, i.e. DALI LIN

CONTACT FACTORY FOR MORE OPTIONS.

Lens & Accessory Options

OPTC-ACC-CL-94MM

Clear Lens

Also available with complete fixture, use ordering code.

-CL



Light Loss Factor: 100%*

*Light Loss Factor calculated with 60° faceted reflector.

OPTC-ACC-DL-94MM

Diffusing Lens

Also available with complete fixture, use ordering code.

-DL



Light Loss Factor: 87%*

Optics

RFLC-FXX-94MM

Faceted Reflector

Also available with complete fixture, use ordering code.

-F10/-F18/-F30/-F45/-F60



FXX	Optic
F10	10° Faceted
F18	18° Faceted
F30	30° Faceted
F45	45° Faceted
F60	60° Faceted
S30	30° Smooth
S45	45° Smooth
S80	80° Smooth

Remote Driver Housing

Depending on the options selected in the order code on page 1, a Remote Driver Housing may be required. This will automatically be generated and put on your order as necessary.

REMOTE DRIVER	MODEL	OUTPUT	CCT	DRIVER	DRIVER OPTIONS
HRM-Housing, Remote	LET11W-WM-Leto 11 Wet Wall Mount	Same as Fixture	Same as Fixture	Same as Fixture	Same as Fixture

Maximum mounting distance to luminaire using 18 AWG wire						
010S	PHSD	010L	010G	DALI DALI8	DMX	LUTE
16'	16'	72'	72'	72'	149'	15'

4" J-box

Minimum volume required to mount drivers in junction box: 70mm x 40mm x 30mm.

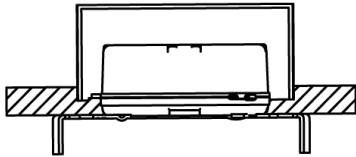

Driver
PHSD
010S

HRM Single with Externally Mounted Driver

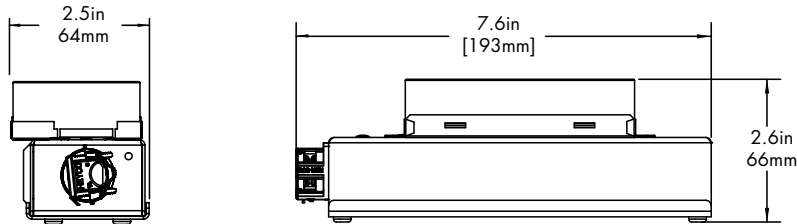

Driver
010L or 010G
010S
010L or 010G or 010S
DALI or LUTE

HRM Single

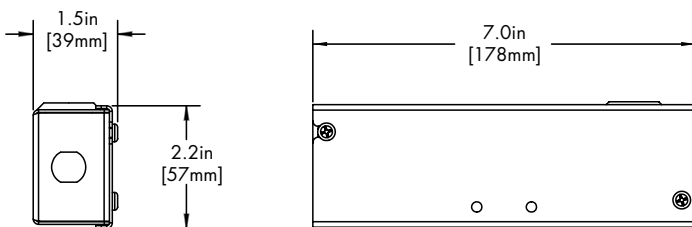

Driver
PHSD

HRM Double

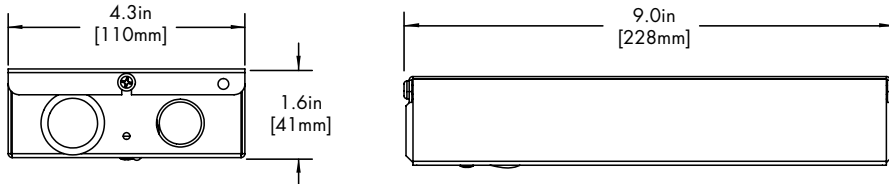

Driver
DALI8
DMX

EMG Emergency Driver

120 minute EMG operation time.

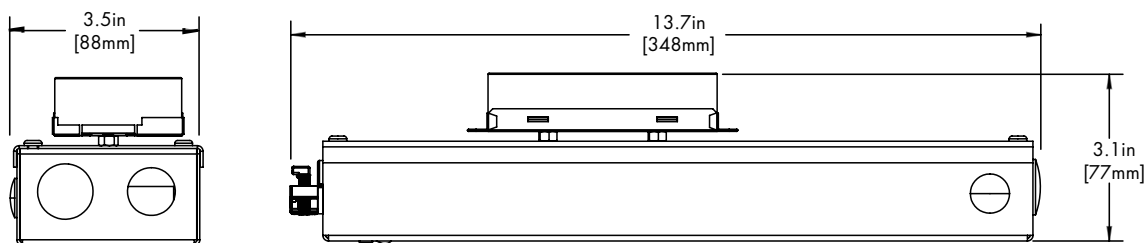

Driver
EMG

LETO 11

WALL MOUNT UP/DOWN WET LED CYLINDER

Standard Colors

BK
Black



WH
White



SL
Silver



Premium Colors

MA
Mocha

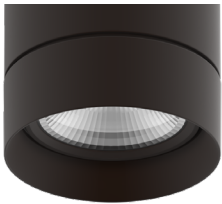

CC
Charcoal

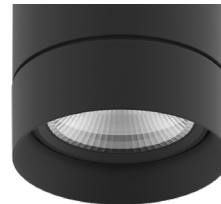

CR
Cerulean

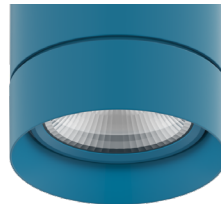

FB
Firebrick

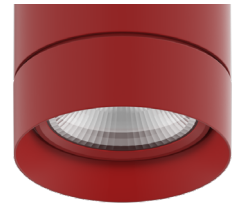

Two Tone Finishes

Inside finish refers to Baffle Finish selection from page 1. Any combination may be used for baffle and body finishes.

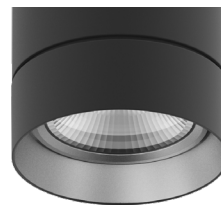
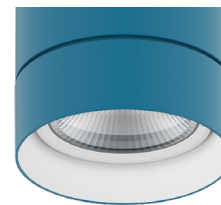
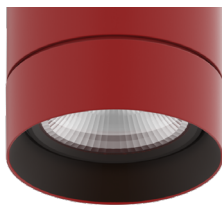

TM-30

2500K

COLOR VECTOR GRAPHIC

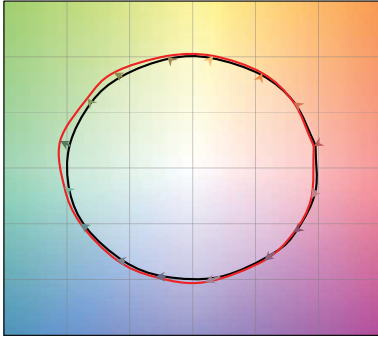

— Reference Source — Test Source

2700K

COLOR VECTOR GRAPHIC

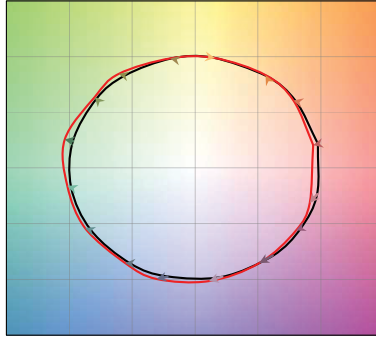

— Reference Source — Test Source

3000K

COLOR VECTOR GRAPHIC

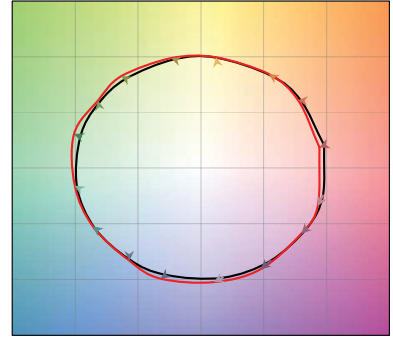

— Reference Source — Test Source

3500K

COLOR VECTOR GRAPHIC

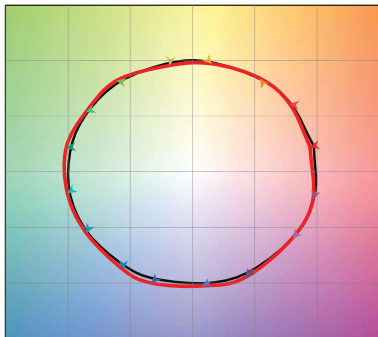

— Reference Source — Test Source

4000K

COLOR VECTOR GRAPHIC

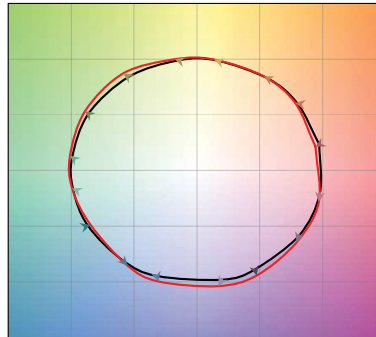

— Reference Source — Test Source

6500K

COLOR VECTOR GRAPHIC

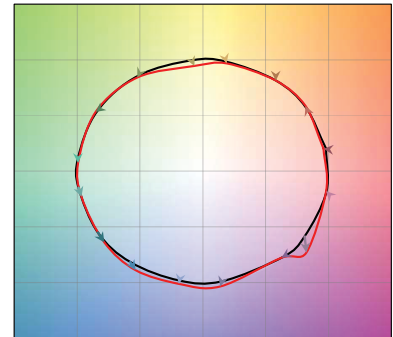

— Reference Source — Test Source

Photometry

LET11-WM-0707-35K-F10-F17-NA

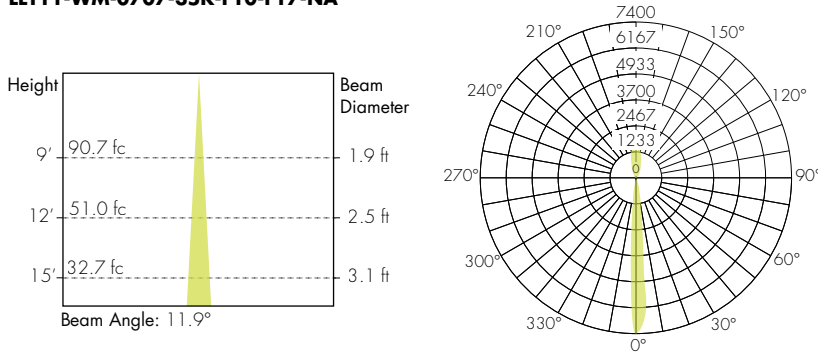

LET11-WM-1010-35K-F10-F17-NA

