

MINIMO PRO TUNABLE WHITE

PRODUCT OVERVIEW

TUNABLE WHITE LIGHT ENGINE



KEY FEATURES

- Beam Options: 25 | 32 | 46 | 56
- Performance: 902lm | 12.60W
- Movement: 360 Pan | 35 Tilt
- Tool-less field changeable optics
- 2 Channel tunable CCT
- Trimmed / Trimless options
- UK Part L1 / L2 (Display) Compliant

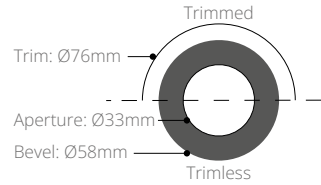

OVERVIEW

Minimo Pro Tunable White is a Constant Current single source pro-series downlight with the option of 2 CCT tuning ranges (1800-3000K / 2700-5000K) and comes as standard in white and black along with a range of premium finishes. It has four site-changeable optics for flexible beam distribution and is fully adjustable with 360° pan and 35° tilt without breaking the ceiling line. Our 902lm | 12.60W light engine has a max peak intensity of 3600cd. The integral accessory holder can accommodate 32mm lenses and louvers.

PERFORMANCE

	Tunable White			
	Medium	Wide	V. Wide	U. Wide
FWHM	25°	32°	46°	56°
Luminous Flux	874 lm	902 lm	892 lm	877 lm
Peak Intensity	3600 cd	2930 cd	1560 cd	1080 cd
CCT	1800-3000K 2700-5000K			
CRI Min.	92 92			
LED Current	0.350 A			
Voltage	36 V			
Input Wattage	12.6 W			
Efficacy	71.6 lm/W			
Driver Type	Constant Current Remote			
Class	SELV Class III			

ORDER CODE

Model	Type	Rating	Trim	Aperture	Output	CCT	Beam Angle	Trim Finish	Aperture Finish
MNP <i>Minimo Pro</i>	D <i>Fixed</i>	20 <i>IP20</i>	TR <i>Trimmed</i>	FP <i>Pinhole</i> ³	TWSO <i>Tunable White</i>	18K30K <i>1800K-3000K</i>	ME <i>Medium 25°</i>	NA <i>Trimless</i>	WH <i>White</i>
	A <i>Adjustable</i>	54 <i>IP54</i>	TL <i>Trimless</i> ¹	BV <i>Beveled</i> ²		27K50K <i>2700K-5000K</i>	WD <i>Wide 32°</i>	WH <i>White</i>	BK <i>Black</i>
							VW <i>Very Wide 46°</i>	BK <i>Black</i>	MG <i>Matt Gold</i>
							UW <i>Ultra Wide 56°</i>	AL <i>Br. Aluminium</i>	
								RBZ <i>R. Bronze</i>	
								BR <i>Br. Brass</i>	
								PB <i>P. Brass</i>	
								CH <i>Chrome</i>	

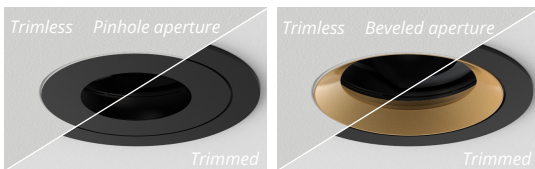

Example code: MNP-D-20-TR-FP-TWSO-18K30K-ME-WH-WH

¹ Trimless trim finish must be NA ² MG Aperture finish only for beveled ³ Pinhole trim finishes only WH/BK/NA

See Drivers, Power Supplies and Accessories sections for further order codes

LIGHT ENGINE SELECTION

This product specification sheet references our 2 channel Tunable White light engine, for Warm Dim please refer to its separate specification sheet.

tunable/**WHITE**

Allows users to adjust the correlated colour temperature (CCT) of their light on demand, with options for analogue, digital, or wireless control. Tuning ranges are available to suit a range of applications.

- 1800K - 3000K
- 2700K - 5000K

LIFETIME & ENVIRONMENTAL

At Precision, we design and engineer our products with longevity in mind. Many of the components that make up our light fixtures are both modular and re-usable, making it possible to service and repair them throughout their life in service. Once our products reach the end of their useful life, it is possible to re-work and renew them in to a new product. We prioritise the use of recyclable materials in both our products and packaging, and encourage our customers to engage responsibly in the correct disposal of any materials we supply.

CIBSE TM65	13.09 Kg/CO2e	UK PART L	
CIBSE TM66	2.2	Part L1A / L1B (Dwellings)	Compliant 110 lm/W ≥75 Lm/W source lumens Source lm (1386 lm) / Source W (12.60 W)
RoHS Compliance	Yes	Part L2A (General)	≥95Lm/W delivered lumens -
REACH Compliance	Yes	Part L2A (Display)	Compliant 110 lm/W ≥80 Lm/W source lumens Source lm (1386 lm) / Source W (12.60 W)
WEEE Compliance	Yes - Registered Producer		
Declare	LBC Red List Approved		
Lifetime	L90B10 50,000hrs		
Warranty	5 Years		

MINIMO PRO TUNABLE WHITE

DIMENSIONS

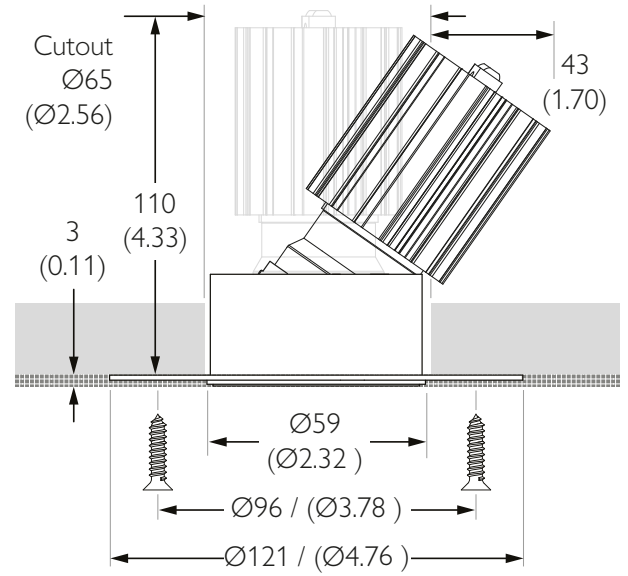
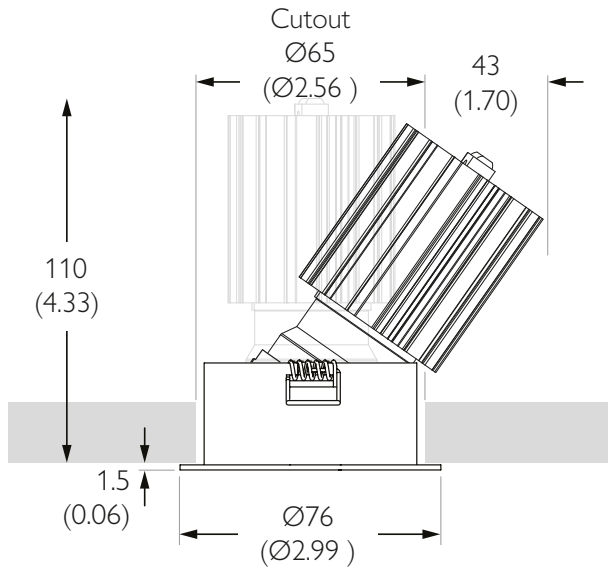

MECHANICAL

Location	IP20 / IP54 Indoor Dry / Damp Location Only
Mounting	Recessed
Adjustability	360 Pan 35 Tilt
Lockable	N/A
Accessories	Louver Lenses

Cutout	ø65mm (2.56")
Ceiling Thickness	3-25mm (0.12-0.98")
Product Class	SELV Class III
Material	Machined AL 6063-T6
Weight	249g 0.55lb

MINIMO PRO TUNABLE WHITE

DIMENSIONS & FINISHES

TUNABLE WHITE LIGHT ENGINE

TRIM & APERTURE TYPES



TRIMMED
PINHOLE



TRIMLESS
PINHOLE



TRIMMED
BEVELED



TRIMLESS
BEVELED

TRIM FINISHES

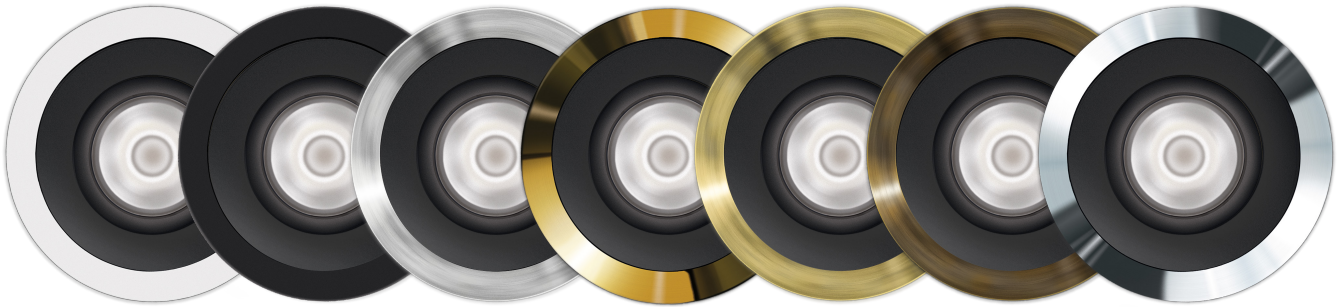

WHITE

BLACK

BRUSHED
ALUMINUM

POLISHED
BRASS

BRUSHED
BRASS

RUBBED
BRONZE

POLISHED
CHROME

APERTURE FINISHES

BEVELED

PINHOLE

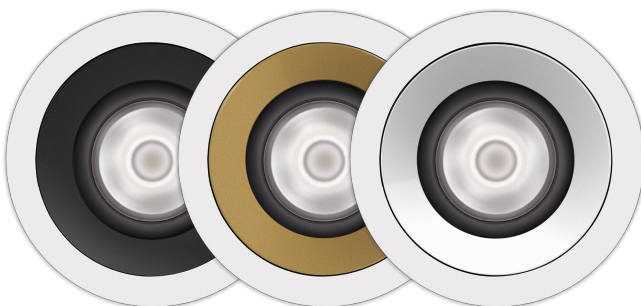

BLACK

MATTE GOLD

WHITE



WHITE



BLACK

MINIMO PRO TUNABLE WHITE

20W | DALI-2 DT6 | Remote | Constant Current

Input Voltage	230VAC 50/60 Hz
Driver Type	Remote Constant Current
Location	IP20 Indoor Location Only
Dimming Control	DALI-2 DT6
Min. Dim Level	0.1%
Flicker	IEEE P1789 Compatible No Observable Effect
Wiring Distance	16 AWG - 36m (118') 18 AWG 22m (72')

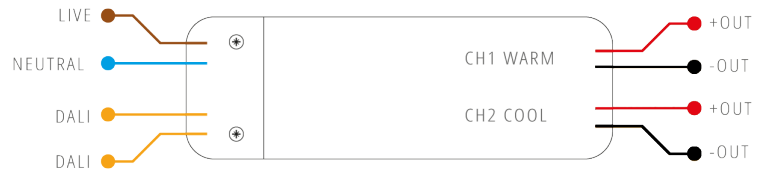

	1800-3000K	2700-5000K		L	W	H
Max. Lights	1 only	1 only	mm	184	41	30
Order Code	PSCC-RM-630T01-01D	PSCC-RM-630T02-01D	in	7.24	1.61	1.18

20W | DALI-2 DT8 | Remote | Constant Current

Input Voltage	230VAC 50/60 Hz
Driver Type	Remote Constant Current
Location	IP20 Indoor Location Only
Dimming Control	DALI-2 DT8
Min. Dim Level	0.1%
Flicker	IEEE P1789 Compatible No Observable Effect
Wiring Distance	16 AWG - 36m (118') 18 AWG 22m (72')

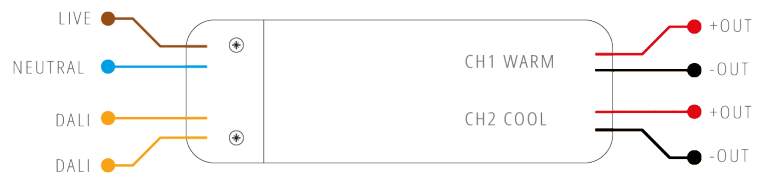

	1800-3000K	2700-5000K		L	W	H
Max. Lights	1 only	1 only	mm	184	41	30
Order Code	PSCC-RM-630T01-01E	PSCC-RM-630T02-01E	in	7.24	1.61	1.18

This product specification sheet is for 230V / CE / UKCA regions. For North American projects please refer to our Minimo - North American specification sheets.

MINIMO PRO TUNABLE WHITE

OUTPUT SCALING

CCT	Output Multiplier	CRI	R9 Typ.	TM-30: Rf	TM-30: Rg	Max Lm
1800K	0.57	92	68	90	99	514
2400K	0.77	92	80	90	99	695
3000K	1.00	92	75	90	99	902
4000K	1.05	91	70	89	101	947
5000K	1.06	91	65	89	99	956

Colour Consistency: 3 SDCM at 3000K



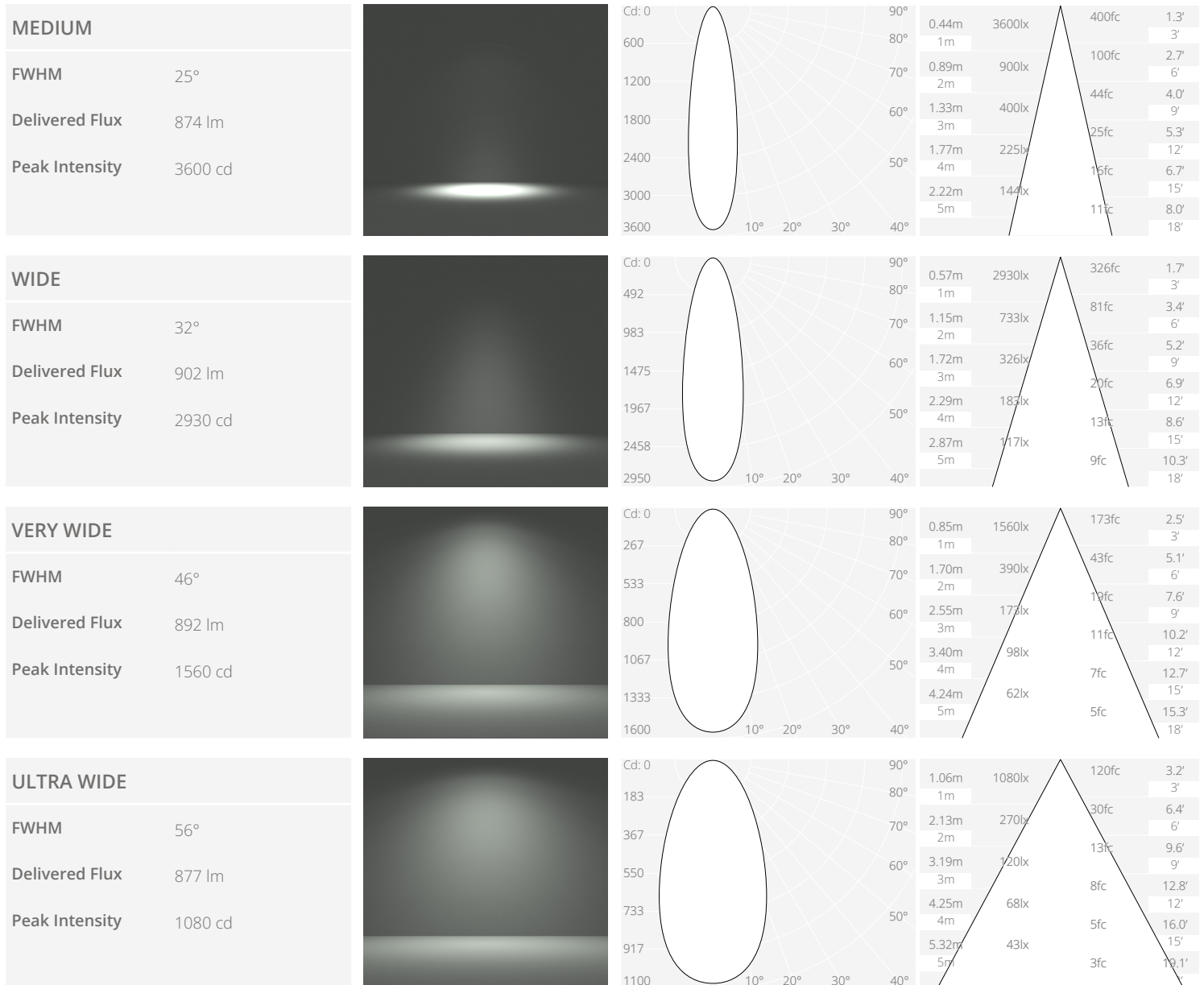

PHOTOMETRY



MINIMO PRO TUNABLE WHITE

OPTICS

There are 4 interchangeable optics, cross reference the molded ID on the optic for beam option.

Optic	Optic	Optic	Optic
			
Medium TIR Optic Molded ID 15 Order Code HKRG-35-15-PC	Very Wide TIR Optic Molded ID 36 Order Code HKRG-35-36-PC	Wide TIR Optic Molded ID 24 Order Code HKRG-35-24-PC	Ultra Wide TIR Optic Molded ID 50 Order Code HKRG-35-50-PC

ACCESSORIES

This product can hold 1 x accessory within the integrated holder. To accommodate additional accessories please contact our sales team. Accessories are pre-installed unless otherwise requested.

Glare Control	Colour Change
	
Honeycomb Louver W32xH3.2mm W1.26xH0.13" Order Code 995-32-BK	1/4 CTO W32xH1.8mm W1.26xH0.07" Order Code 997-1/4CTO-32

MINIMO PRO TUNABLE WHITE

